



HAL
open science

Photocatalytic degradation of organic pollutant with polypyrrole nanostructures under UV and visible light

Xiaojiao Yuan, Dita Floresyona, Pierre-Henri Aubert, Thanh-Tuân Bui, Samy Remita, Srabanti Ghosh, François Brisset, Fabrice Goubard, Hynd Remita

► **To cite this version:**

Xiaojiao Yuan, Dita Floresyona, Pierre-Henri Aubert, Thanh-Tuân Bui, Samy Remita, et al.. Photocatalytic degradation of organic pollutant with polypyrrole nanostructures under UV and visible light. *Applied Catalysis B: Environmental*, 2019, 242, pp.284-292. <10.1016/j.apcatb.2018.10.002>. <hal-04216406>

HAL Id: hal-04216406

<https://universite-paris-saclay.hal.science/hal-04216406v1>

Submitted on 26 Sep 2023

HAL is a multi-disciplinary open access archive for the deposit and dissemination of scientific research documents, whether they are published or not. The documents may come from teaching and research institutions in France or abroad, or from public or private research centers.

L'archive ouverte pluridisciplinaire **HAL**, est destinée au dépôt et à la diffusion de documents scientifiques de niveau recherche, publiés ou non, émanant des établissements d'enseignement et de recherche français ou étrangers, des laboratoires publics ou privés.



HAL Authorization

Photocatalytic Degradation of Organic Pollutant with Polypyrrole Nanostructures under UV and Visible light

Xiaojiao Yuan,¹ Dita Floresyona,¹ Pierre-Henri Aubert,² Thanh-Tuân Bui,² Samy Remita,^{1,3} Srabanti Ghosh,^{1,†} François Brisset,⁴ Fabrice Goubard,² Hynd Remita^{1,5*}

¹ Laboratoire de Chimie Physique, UMR 8000 CNRS, Université Paris-Sud, Université Paris-Saclay, 91405 Orsay, France

² Laboratoire de Physicochimie des Polymères et des Interfaces (LPPI, EA 2528), Université de Cergy-Pontoise, F-95031 Neuville-sur-Oise Cedex, France

³ Département Chimie Vivant Santé, EPN 7, Conservatoire National des Arts et Métiers, CNAM, 292 rue Saint-Martin, 75141 Paris Cedex 03, France

⁴ Institut de Chimie Moléculaire et des Matériaux d'Orsay, ICMMO, UMR 8182 CNRS, Université Paris-Sud, Université Paris Saclay, Bât 410-420, Orsay F-91405, France

⁵ CNRS, Laboratoire de Chimie Physique, UMR 8000, 91405 Orsay, France

Abstract:

Conjugated polymer nanostructures (CPNs) emerge as a new class of photocatalysts for organic pollutant degradation under UV and visible light. Polypyrrole (PPy), as a conjugated polymer, exhibits

Corresponding author's email address: hynd.remita@u-psud.fr

[†] Present address: Fuel Cell & Battery division, CSIR-Central Glass and Ceramic Research Institute, 196, Raja S.C. Mullick Road, Kolkata- 700032, India

a wide range of applications. We present here the first demonstration of employing pure PPy nanostructures as a very efficient photocatalyst for water depollution. PPy nanostructures were synthesized in hexagonal mesophases (used as soft templates) by chemical polymerization (PPy-NS-c), obtained by radiolysis (PPy-NS- γ), and synthesized without any template via chemical method (PPy-bulk) as bulk. The different PPy samples were characterized by SEM, TEM, FTIR and UV-Vis absorption spectroscopy. The photocatalytic activity of both PPy nanostructures (PPy-NS-c and PPy-NS- γ), which remain very stable after several cycles, was evaluated for the degradation of organic pollutant in aqueous solution (phenol and methyl orange were taken as a model pollutant). PPy nanostructures show high photocatalytic activity under both UV and visible light while bulk PPy (PPy-bulk) has no appreciable activity. PPy-NS-c present the highest activity for photodegradation of phenol under UV light, while PPy-NS- γ exhibit the best photocatalytic activity under visible light. We demonstrate here that the nanostructuration of these polymers is an important key factor for their application in photocatalysis.

Key Words: Polypyrrole, Conjugated Polymers, Nanostructures, Photocatalysis, Water Depollution.

1. Introduction

TiO₂ is the most widely used photocatalyst because of its nontoxicity, mechanical stability, corrosion resistance, high photocatalytic activity and low price. Nevertheless, TiO₂ is only active under UV light because of its large band gap (3.2 eV for anatase and 3.0 eV for rutile)[1], which constitutes 3-4 % of the solar light impinging on the Earth's surface. To overcome this limitation and extend its

photocatalytic activity toward the visible region, a great number of efforts have been made either via doping of TiO₂ with N, C or S or by its surface modification with metal nanoparticles (NPs) such as Ag, Au, Pt, Pd NPs [2-10].

Besides, the development of efficient, durable and cost-effective materials for photocatalytic applications and solar energy conversion is crucial for environmental applications and solar fuel production. In this context, different semiconductor nanostructures and novel photocatalysts have been proposed for solar energy conversion such as bismuth-based oxides [11, 12], lanthanide stannates [13-16], spinel compounds [17], ZnO-based nanocomposites [18], graphene oxides [19-21] and conducting polymer nanostructures [22, 23].

Since MacDiarmid and co-workers discovered conducting polyacetylene (PA) doped with iodine in 1977, conducting polymers (CPs) have drawn much attention for energy conversion and storage applications such as solar cells, fuel cells and rechargeable lithium batteries [24-31]. Conducting polymers offer the advantages of their low cost, facile synthesis, excellent electrochemical performance, great electrical conductivity and high carrier mobility. Conjugated polymers, as a new class of photocatalysts, is very active under UV and visible light [22, 23, 32, 33]. Novel organic polymeric based materials have recently made an upsurge in photocatalysis and solar energy conversion [34]. For example, g-C₃N₄ is a thermally and chemically stable semiconducting material that was discovered to photocatalyze a wide variety of chemical reactions including the water splitting reaction [35-39].

Recently, we developed an alternative radiolytic methodology for the synthesis of conducting polymers either in aqueous solutions or in organic solvents thanks to the use of high-energy radiations [40-47]. Also, the controlled synthesis in soft templates (made of hexagonal mesophases) of conjugated polymer nanostructures (CPNs) such as poly(diphenylbutadiene) (PDPB) [48], poly(3,4-ethylenedioxythiophene) (PEDOT) [49], and poly(3-hexylthiophene) (P3HT) [23] has been reported by our group. We have demonstrated for the first time in the literature that these CPNs are highly active photocatalysts under UV and visible light, and more interestingly that their photocatalytic activity under visible irradiation is higher than that of plasmonic TiO₂ (titania modified with silver nanoparticles) [22]. In all cases, the polymer nanostructures were synthesized in soft templates made by hexagonal mesophases. In spite of using various methodology (radiolysis or photochemical polymerization for PDPB or chemical oxidation for PEDOT and P3HT), polymerization has always been shown to proceed in the confined hydrophobic domain (oil cylinders) of the hexagonal mesophases [50]. The as-prepared nanometric sized polymeric material can be extracted from the hexagonal mesophases by simple addition of ethanol [32, 48, 51, 52]. Importantly, the beneficial role of the nanostructuring of the polymer for its photocatalytic activity in the visible region was clearly observed, since the bulk counterpart exhibited very low photocatalytic activity [23, 49, 50].

Polypyrrole (PPy) is considered as one of the well explored conjugated polymer for different applications such as actuators [53], supercapacitor electrodes [54, 55], ablation of cancer cells [56, 57], fuel cells, and catalysis [58] owing to its high electrical conductivity, high stability, high carrier mobility, excellent electrochemical activity, facile synthesis and strong binding or tethering sites for sequential reactions. A variety of synthesis methods such as templated-based and template-free

synthesis have been developed to prepare PPy nanostructures of different morphologies [40]. Using soft templates, different morphologies were obtained by controlling the concentrations of the surfactants and that of the monomers [59, 60]. For photocatalytic application in water treatment, composite nanomaterials based on PPy associated to inorganic semiconductors have been also developed such as polypyrrole-TiO₂ [61], AgCl/PPy [62], and PPy/Bi₂O₂CO₃ [63] etc.

Here, we demonstrate for the first-time the high photocatalytic activity of bare polypyrrole nanostructures for water treatment. We show that PPy conjugated polymers are highly efficient for degradation of organic pollutants (phenol taken as a model pollutant) under both ultraviolet and visible light irradiation. We report on the synthesis of PPy nanostructures with three different approaches: *i*) in soft templates using swollen hexagonal mesophases by chemical oxidation (PPy-NS-c), *ii*) in the absence of any template by direct gamma irradiation synthesis (PPy-NS- γ), and *iii*) without any templates by chemical oxidation (PPy-bulk). PPy nanostructures are stable under photocatalytic cycling. The photocatalytic activities of these PPy structures were investigated and compared. The photocatalytic mechanism was also studied and discussed in details.

2. Experimental section

2.1. Materials and reagents

Pyrrole (Py) (98%, Aldrich Chemical Co.), as monomer, iron (III) chloride (FeCl₃) as oxidative agent, sodium dodecyl sulfate (SDS) as surfactant, sodium chloride (NaCl), copper (II) sulfate pentahydrate (~99%), methyl orange (MO), cyclohexane (99.7%), phenol, 2-propanol (99.5%), tert-

butanol ($\geq 99.5\%$), ethanol ($\geq 99\%$ for HPLC) were purchased from Sigma-Aldrich, and n-pentanol was purchased from Honeywell ($\geq 99\%$). All the reagents were analytically pure, commercially available and used without further purification. Ultrapure water (Millipore System, $18.2 \text{ M}\Omega \text{ cm}$) was used.

2.2. Photocatalysts Preparation

In this work, we used three methods to synthesize PPy:

(i) The as-prepared sample PPy-NS- γ was synthesized by radiolysis without any template and the color of the solution varied from the transparent solution (before irradiation) to black solution (after irradiation) (Scheme 1). PPy-NS- γ are obtained by oxidation of the Py monomer by HO^\bullet radicals in water solution. The synthesis procedure was adapted from the ref. [40] with few modifications. In brief, an aqueous solution containing 20 mM pyrrole was degassed with N_2O for 20 min and irradiated with a ^{60}Co panoramic γ -source at a dose rate of $4.1 \text{ kG}\cdot\text{h}^{-1}$. The used dose was 77 kGy. After drying in the oven at $50 \text{ }^\circ\text{C}$, a black powder was obtained: PPy-NS- γ .

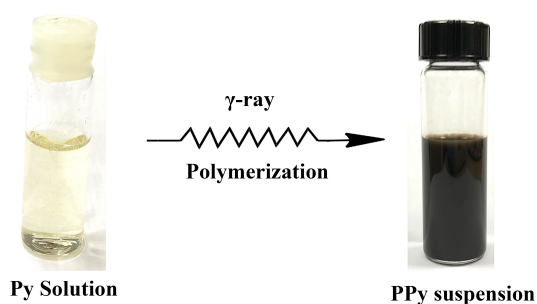

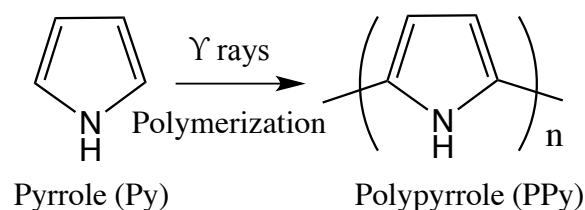

Scheme 1. PPy Polymerization by radiolysis.

(ii) PPy-NS-c nanostructures were synthesized by chemical oxidation of the PPy monomer confined in the oil phase of hexagonal mesophases (0.1 mM). Hexagonal mesophases are made of a mixture of sodium dodecyl sulfate (SDS) as surfactant, salted water phase (NaCl, and containing FeCl₃ and Py in this study), cyclohexane as oil phase and pentanol as cosurfactant. These mesophases are composed of oil-swollen surfactant tubes arranged on a triangular lattice in water and doped with Py monomer in water phases (in our case) were used as soft templates for the synthesis of PPY nanostructures. Formation of hexagonal mesophases was described in details in previous works [32, 48, 50-52]. As shown in **Fig.1**, 7 μL Py was added to 2 mL of an aqueous solution containing 0.1 M NaCl, and 0.8 g SDS were introduced to the obtained solution. The mixture is vortexed for few minutes and then put in an oven at 50 °C for 1 h: A transparent viscous micellar solution (solution A) is obtained. 0.1 M FeCl₃ was dissolved in 2 mL of water. 0.8 g SDS is introduced in the solution and the mixture is mixed, vortexed and put in an oven at 50 °C for 1 h (solution B). Subsequently, 3 mL of cyclohexane was added to each micellar solution (solution A and B, respectively). The ratio monomer/oxidant [Py]/[FeCl₃] was 1/2. After vortexed a few minutes, 400 μL n-pentanol (co-surfactant) were added dropwise. The mixtures were then vortexed until a transparent (A) and yellow translucent (B), birefringent gels (hexagonal mesophases) were obtained. Mixing A and B lead to a black gel (C). During the process, the color of the mesophases changed very fast from transparent to black (**Fig. 2**).

The PPy nanostructures were extracted by addition of ethanol, which destabilizes the mesophase. After centrifugation of the suspensions, PPy nanostructures were washed several times with ethanol and dried in the oven at 60 °C: A black powder (D) was then obtained.

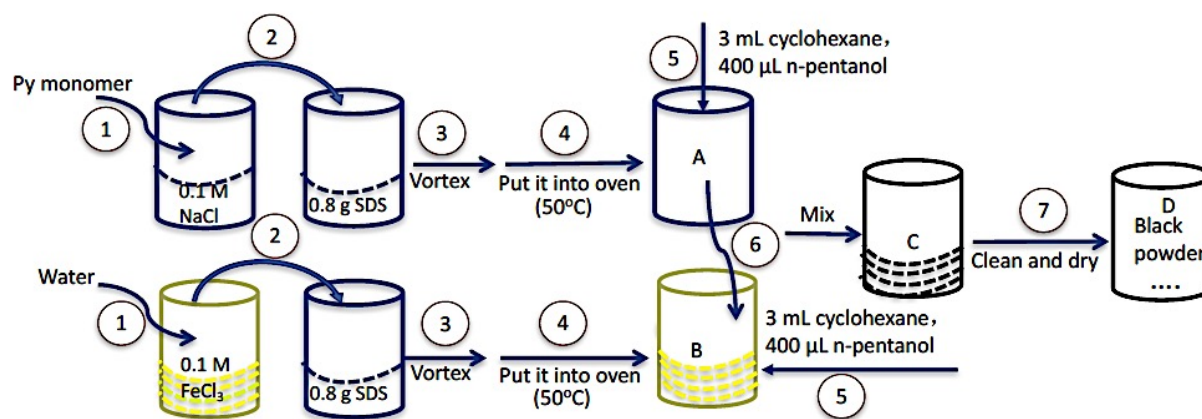

Fig. 1. The flow-process diagram of PPy-NS-c synthesis.

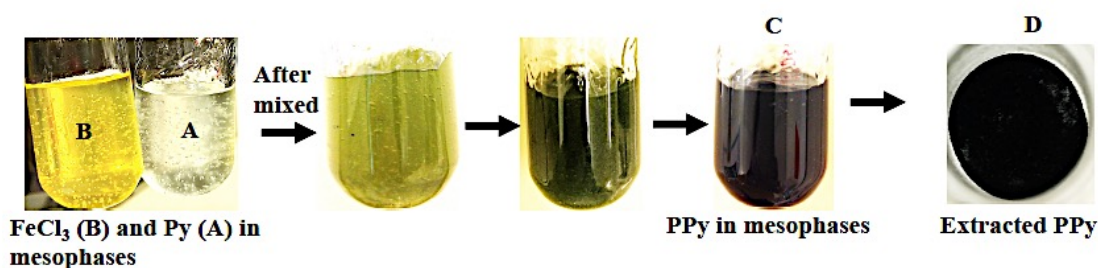

Fig. 2. Colour variation during the synthesis process in mesophases leading to PPy-NS-c.

(iii) PPy-bulk was synthesized by chemical oxidation (using FeCl_3 as oxidant) in water without any surfactant nor irradiation. The ratio monomer/oxidant $[\text{Py}]/[\text{FeCl}_3] = 1/2$ (the same ratio as that used for synthesis of PPy-NS-c). After centrifugation of the suspensions, bulk-PPy PPy were washed several times with ethanol and dried in the oven at 60 °C.

2.3. Characterization

The different materials were characterized by FT-IR, SEM, TEM, UV-Vis absorption spectroscopy and Maldi-TOF.

Fourier transform infrared (FT-IR) spectra were obtained by using the FTIR spectrometer (Bruker Vertex 70) with a diamond ATR attachment (PIKEMIRACLE crystal plate diamond/ZnSe) and MCT detector with a liquid nitrogen cooling system.

The morphologies and nanostructures of the solid samples were characterized by scanning electron microscopy (SEM, ZEISS Supra 55VP FEG-SEM at 1kV) and by transmission electron microscopy (TEM, JEOL JEM 100CX).

UV-Vis absorption spectra of PPy suspension were recorded with a UV-vis scanning spectrophotometer (HP 8453) in quartz cell.

Maldi-TOF (Matrix Assisted Laser Desorption/Ionization Time of Flight) mass spectrometry (Xevo Q-ToF WATERS) was used to determine the polymerization degree. The suspension of PPy in water was mixed with a matrix solution. The matrix solution was then placed on a stainless-steel plate. The spectra were obtained in the reflection mode and in the positive ion mode.

2.4. Electrical Conductivity: To measure the electrical conductivity of PPy, the Kelvin four-point probe technique was used to measure the resistance of the as-prepared samples. Before measurements, PPy films were obtained by spin coating with a small drop of PPy suspensions on a glass substrate. The suspensions were doped with NOBF_4 (200 mM) in acetonitrile. A 3 Veeco Dektak 150 surface profiler was used to measure the thickness of the film.

According to the following equation, the conductivity (ρ , $S \cdot \text{cm}^{-1}$) was obtained:

$$\rho = \left(\frac{\pi}{\ln 2} \times \frac{V}{I} \times t \right)^{-1}$$

where V is the voltage (V), I is the applied current (A) and t is the thickness of the films (cm).

2.5. Electrochemical Measurements: Cyclic voltammograms (CV) of PPy were measured by IUPAC. The oxidation potential (E_{ox}) of the investigated compounds were measured in dichloromethane by cyclic voltammetry with tetrabutylammonium perchlorate (0.1 M) as a supporting electrolyte in a standard one-compartment, three-electrode electrochemical cell under an argon stream using a VSP BioLogic potentiostat and scan rate was 20 mV s^{-1} . Platinum disk ($\text{Ø} = 1 \text{ mm}$), Ag wire pseudo-reference, and gold electrodes were used as working, reference and counter electrodes, respectively. Ferrocene was used as an internal standard, and the potentials were referred to the reversible formal potential of this compound.

2.6. Photocatalytic Tests.

The photocatalytic activities of PPy samples were evaluated for degradation of phenol ($\text{C}_6\text{H}_5\text{OH}$, 50 ppm) and methyl orange (MO, 500 ppm) taken as model pollutants. Before photocatalytic experiments, the suspensions containing the PPy and the model pollutant were stirred in the dark for 2 h to ensure adsorption-desorption equilibrium. Then, the suspension was exposed to light under stirring and O_2 bubbling. An Oriel 300 W Xenon lamp with an infrared water filter and a 400-nm cut off filter for the experiment under visible light was used as the light source. In details, 3 mg of PPy powder were added into 3 mL phenol aqueous solution with stirring. 300 μL of the suspension were taken out every 1 h of irradiation and the mixture was centrifuged to remove the PPy nanostructures.

High pressure liquid chromatography (HPLC) was used to determine the concentration of phenol and to calculate its photocatalytic degradation activity. Degradation of MO was followed by UV-visible spectrophotometric method at 460 nm wavelength. The degradation rate of phenol is expressed as $(C_0 - C)/C_0 \times 100\%$, where C_0 is the initial concentration of phenol and C represents the concentration of phenol after every interval of 1 h.

The mineralization of phenol was measured by the total organic carbon (TOC) using a Shimadzu TOC-LCSH.

Tris(hydroxymethyl) aminomethane (noted Tris) was used as a probe to determine the hydroxyl radical concentration [22, 49, 64]. Hydroxyl radicals and formaldehyde are produced during the reaction between Tris and hydrogen-abstracting species. The concentration of the formaldehyde was quantified by means of the Hantzsch method [65].

3. Results and Discussions

Swollen hexagonal mesophases were used as soft templates to synthesize PPy nanostructures (PPy-NS-c). These mesophases consisted of oil-swollen surfactant tubes ordered on a triangular lattice in water [66, 67]. The hydrophobic domain of the mesophases can accommodate high concentrations (up to 0.1 M) of PPy monomer, which is polymerized by FeCl_3 (oxidant). The mechanism of chemical oxidation of Py leading to PPy is described in the literature [68].

Other nanostructures of PPy were synthesized by radiolysis (PPy-NS- γ) [40]. Radiolysis of aqueous solution is an efficient way to polymerize monomers into polymers by oxidative hydroxyl

radicals Reaction (1)[40]. Water radiolysis produces solvated electrons and radicals (HO^\bullet and H^\bullet):

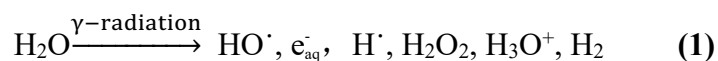

To scavenge electrons and produce more oxidative HO^\bullet radicals, the aqueous solution is degassed with N_2O : $e_{\text{s}} + \text{N}_2\text{O} + \text{H}_2\text{O} \rightarrow \text{HO}^\bullet + \text{HO}^- + \text{N}_2$.

Radiolytic polymerization of PPy is described in details [40].

3.1. Characterizations of PPy nanostructures

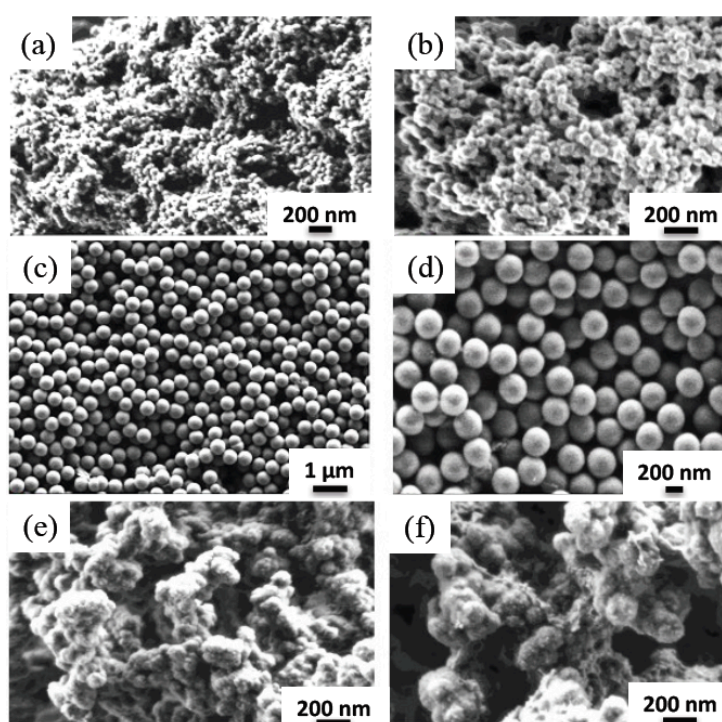

Fig. 3. SEM images of PPy-NS-c (a-b), PPy-NS- γ (c-d), and PPy-bulk (e-f).

SEM images present for PPy-NS-c homogeneous spherical nanostructures with an average size of 40 nm (**Fig. 3a-b**). Similar nanoparticles have been observed using TEM (**Fig. S1**). By contrast, PPy-NS- γ , synthesized by radiolysis, show nanoballs of uniform sizes of 400 nm (**Fig. 3c-d**), which correspond to the TEM images of PPy-NS- γ (**Fig. S2**). In case of chemical polymerization without template, amorphous particles connected in necklaces are obtained (PPy-bulk) (**Fig.3e-f**). Thanks to

the confinement provided by the non-polar tubes of hexagonal mesophases used as soft template or γ -ray irradiation technique, we were able to control and direct the size and morphology of a variety of CPs, and hence to obtain polymer nanospheres.

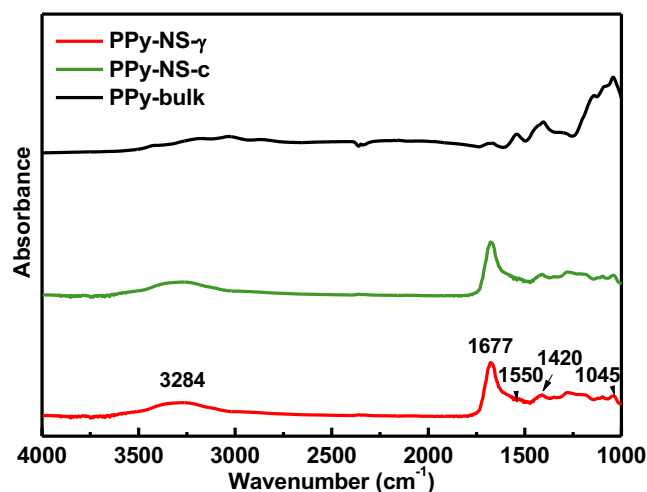

Fig. 4. ATR-FTIR spectra of PPy-NS-c, PPy-NS- γ , PPy-bulk.

The FTIR spectra of PPy-NS-c, PPy-NS- γ and PPy-bulk (**Fig. 4**) have been compared to those of PPy reported in the literature.[40, 69-72] The major peaks in the 1400 to 1600 cm^{-1} region is associated with the formation of the π conjugated polyene unit. The band located at 1420 cm^{-1} corresponds to the C-N stretching vibration from pyrrole ring, and the low intensity peak at 1550 cm^{-1} is ascribed to the C=C/ C-C stretching of PPy, whereas peak at 1677 cm^{-1} could represent to C=N. The band of =C-H in plane-deformation vibration is situated at 1045 cm^{-1} .

Furthermore, no significant difference exists between the nanostructures synthesized by chemical oxidation or by radiolysis. Compared with PPy-bulk, some bands of PPy-NS-c and PPy-NS- γ are slightly shifted. The occurrence of small peak at 3284 cm^{-1} could be assigned to presence of N-H

stretching vibrations. The main absorption bands of PPy-bulk are similar to PPy-NS-c and PPy-NS- γ and are shown in **Fig. 4**. These spectra revealed that PPy was successfully synthesized by chemical oxidative method and by radiolysis.

The maximum molecular weight of PPy-NS-c and PPy-NS- γ determined by Maldi-TOF mass spectroscopy was found to be respectively 1747 and 1709 g mol⁻¹ corresponding to 26 and 25 repeated unite of Py monomers (See **Fig. S3-4**).

Fig.5 shows UV-vis spectra recorded for a dispersion of PPy nanostructures in water. The spectra are similar to that in the previous reports [73-75]. The spectrum of PPy-NS- γ exhibits short wavelength absorption edge at about 425 nm, and the optical band gap is estimated equal to 2.41 eV. While PPy-NS-c shows absorption at shorter wavelength at 300 nm. Obviously, PPy-NS-c exhibits a small absorption in the visible region (≥ 400 nm), indicating that part of visible light can be transmitted through PPy solution. The peak at around 470 nm is due to the π - π^* transitions [76]. Interestingly, there is a high absorption intensity from the visible region to near-IR region (700 nm~1000 nm), which is the characteristic of the polaronic and bipolaronic transitions [56, 75]. PPy-bulk agglomerate into larger particles that cannot be dispersed in ethanol and other solvents.

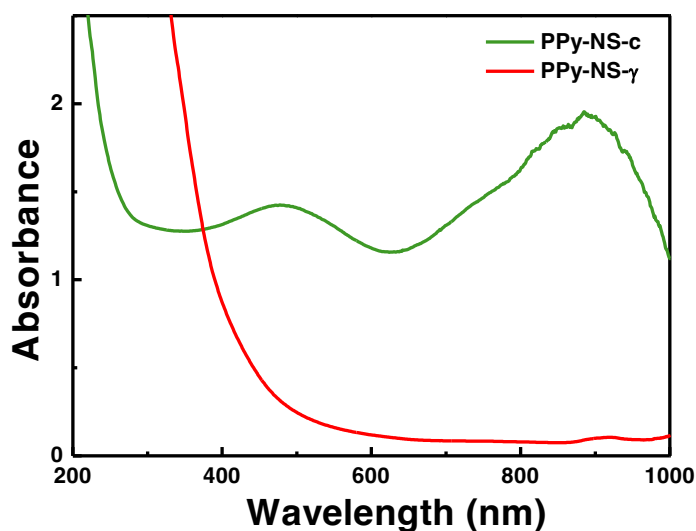

Fig. 5: UV-Vis spectra of the PPy nanostructures (PPy-NS-c and PPy-NS- γ) and PPy-bulk in powder and in suspension.

To investigate the electrical conductivity of PPy, four-point probe technique was used to measure the resistance of the samples. The results show that PPy-NS-c nanostructures present the highest conductive performance. The electrical conductivity of the three samples, such as PPy-bulk, PPy-NS- γ and PPy-NS-c were $7.5 \times 10^{-5} \text{ S} \cdot \text{cm}^{-1}$, $3.6 \times 10^{-3} \text{ S} \cdot \text{cm}^{-1}$, $4.3 \times 10^{-2} \text{ S} \cdot \text{cm}^{-1}$, respectively. It has to be noted that the conductivity increases drastically with the decreased diameter of the PPy particles and the smaller particles size corresponds to the higher surface area for electron transfer [77]. The highest conductivity of PPy-NS-c nanoparticles may be owing to smaller size, less defects, and larger surface areas. In fact, as the diameter decreases, the delocalization of charge carriers over an extended region of the polymer chains could be enhanced by higher surface area, and more ordered chains of connected structures of PPy-NS-c networks could counteract the influence of insulated cavities [40]. Similar

results were obtained by our group for PDPB nanofibers synthesized in hexagonal mesophases. Indeed, the conductivity was found to increase with decreasing the diameter of the nanofibers [48].

3.2. Photocatalytic tests

The photocatalytic activity of the PPy samples was evaluated for degradation of phenol (initial concentration $C_0=0.5$ mM) and methyl orange (MO) ($C_0=0.5$ mM) in aqueous solution under UV and visible light irradiation. Phenol was taken as model pollutant: It is stable under irradiation (no photolysis) and its intermediate degradation products are well known. Methyl orange, as an azo dye, is fairly stable (almost no photolysis was observed under solar light irradiation). Before irradiation, dark adsorption-desorption equilibrium and photolysis experiments were conducted. The rate of adsorption of phenol on PPy-NS-c is about 10% and the photolysis rate is about 3% after 5 h (**Fig. S5**). As shown in **Fig. 6a**, PPy-NS-c and PPy-NS- γ nanostructures exhibit higher degradation rate of phenol compared with PPy-bulk under UV light. Moreover, PPy-NS-c shows the best photocatalytic activity under UV light compared with PPy-NS- γ and PPy-bulk, with degradation rate of phenol about 100% after 4.5 h, while the photodegradation rate of PPy-NS- γ and PPy-bulk are about 80 % and 37% after 5 h, respectively (Ag nanoparticles modified TiO₂ and P25 show the high activity under UV light). More interestingly, PPy-NS- γ present a high photocatalytic activity under visible light. 20% degradation rate is achieved by PPy-NS- γ after 5 h irradiation whereas with PPy-NS-c and PPy-bulk, 10% and 5% degradation are reached respectively (**Fig. 6b**). This activity is close to that of plasmonic TiO₂ (TiO₂-P25 modified with Ag NPs)[78]. While the photocatalytic degradation of MO using PPy-NS-c is about 80% after 5 h under UV light and 10% under visible light, which is lower than phenol degradation (**Fig. S6**). The total mineralization of phenol was followed using as a ordinary technique,

the value of the total organic carbon (TOC) for expressing the detoxification level of water. The PPy nanostructures are able to fully oxidize the organic pollutants, with an almost complete mineralization of carbon into CO₂ and H₂O. The results from TOC indicate that ~90% mineralization of phenol and ~79% mineralization of MO were achieved after 5 h irradiation (UV) with PPy-NS-c. Some related works on phenol degradation with different photocatalysts have been listed in **Table S1** for comparison.

Furthermore, stability with cycling is another important factor for the applications in photocatalysis. In order to evaluate the stability of the conjugated polymer PPy nanostructures for practical application, the stability of PPy with cycling was studied. During the photocatalytic cycles, PPy NSs only shows a slight decrease trend, for example, the degradation rate of phenol is up to 87% at the fourth cycle (**Fig. 6c**) and there is no difference of morphology after 4 cycles (**Fig. S7**). This small decrease is due to the loss of the photocatalyst during the tests, as the samples are centrifuged and washed for further use. These results demonstrate that the as-prepared PPy NSs are very promising for water treatment and other photocatalytic applications. Our study also proves that nanostructuring of CPs is a key factor for photocatalytic applications. However, conjugated polymer nanostructures are very active photocatalysts under UV and visible light, while the bulk polymer counterparts have no significant photoactivity. The difference of photocatalytic activity between nanostructures and bulk conjugated polymer has been assigned to *(i)* the presence of more defects in bulk polymers favoring higher electron-hole recombination, and *(ii)* higher surface area with decreasing the size of the CPs [22, 50].

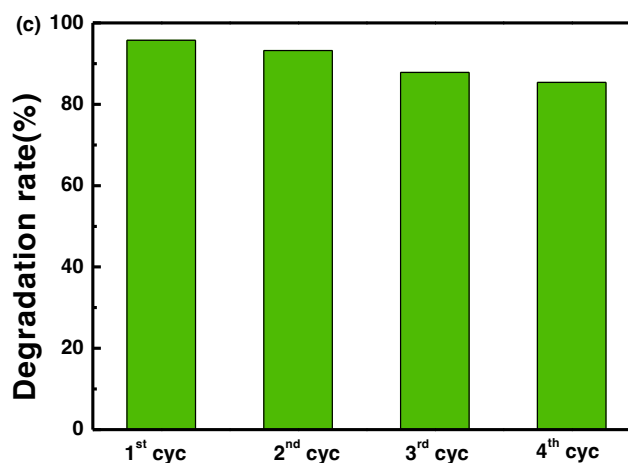
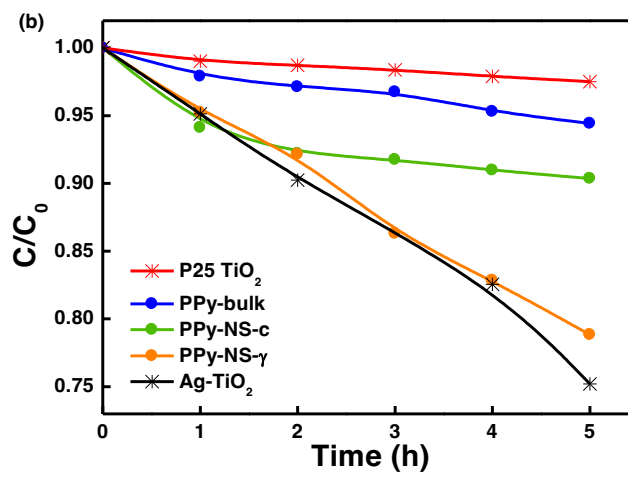
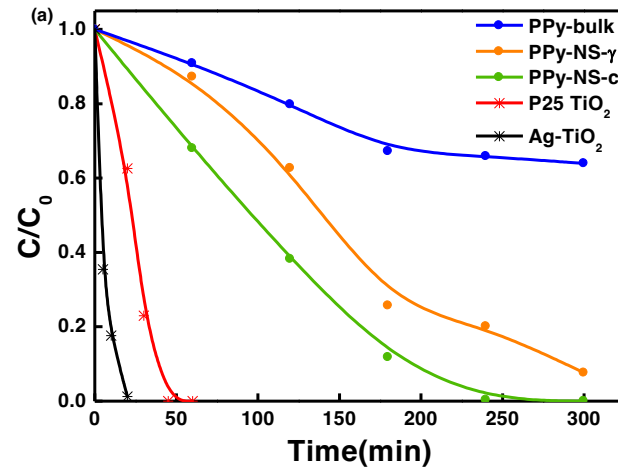

Fig. 6: Degradation rates of phenol in the presence of as-prepared samples of PPy under UV-Vis **(a)** and visible light irradiation **(b)**; **(c)** Photocatalytic activity of PPy-NS-c with cycling.

3.3. Photocatalytic mechanism

We investigated the electronic properties of the synthesized PPy structures to understand their original photocatalytic activity under UV and visible light. When a semiconductor absorbs photons of energy higher or equal to the band gap, electrons (e^-) can be promoted from the valence band (VB) to the conduction band (CB), leaving holes (h^+) in the VB. Consequently, the e^- and h^+ , when they escape recombination, can migrate to the surface of the photocatalysts where they participate in redox reactions with adsorbed species [79]. In the presence of dioxygen, e^- react with it to form the oxidizing $O_2^{\cdot-}$ superoxide radicals ($E^0(O_2/O_2^{\cdot-}) = -0.33 V_{SHE}$) (Eq.1) and h^+ may be trapped by H_2O or HO^- to produce hydroxyl radicals (HO^{\cdot}) (Eq.2-4).



$O_2^{\cdot-}$ is very reactive so that it can oxidize molecules and transform into HO^{\cdot} through the following reactions:

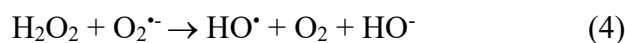

While in HOMO level, the holes might react with HO^- (or H_2O) to yield oxidative HO^{\cdot} radicals:

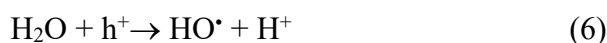

These radicals are very active so that they can oxidize the organic pollutant (such as phenol [80] and MO [81, 82]) to form CO₂ and H₂O. Experiments were conducted in the presence of different scavengers to investigate the role of the radicals in the photocatalytic degradation process.

In the absence of O₂ (experiments under N₂ atmosphere) the activity of PPy-NS-c for phenol degradation decreases from 100% to 15% under UV and from 22% to 8% under visible light irradiation after 5 h, respectively (**Fig. S8, S9**). This indicates that the present of O₂ is an important factor during the photocatalytic process.

Fig. 7a shows the degradation of phenol at the presence of PPy-NS-c using different electron scavengers under UV light. The experiments were conducted in the presence of Cu²⁺ to scavenge electrons (forming Cu⁺). The photodegradation rate of phenol is reduced from 100 % to 87 % in the presence of CuSO₄. Experiments with CuSO₄ show much lower degradation rates of phenol. Cu²⁺ reacts with electrons to produce Cu⁺, and this reaction is in competition with reaction (1). The presence of Cu²⁺ leads to a decrease in the production of O₂^{•-} in the photocatalytic process, which causes a decrease in the degradation kinetics.

Other electron scavengers (1×10⁻⁴ M of (NH₄)₂O₈ and 1×10⁻⁴ M of H₂O₂) were added to the suspension to investigate the photocatalytic activity. After 5 h, the photocatalytic degradation of phenol was 20% and 35% in the presence of (NH₄)₂O₈ and H₂O₂, respectively. These results indicate that addition of electron scavengers leads to lower photocatalytic degradation rate and Cu²⁺ are the most active species for scavenging electrons compared to the (NH₄)₂O₈ and H₂O₂.

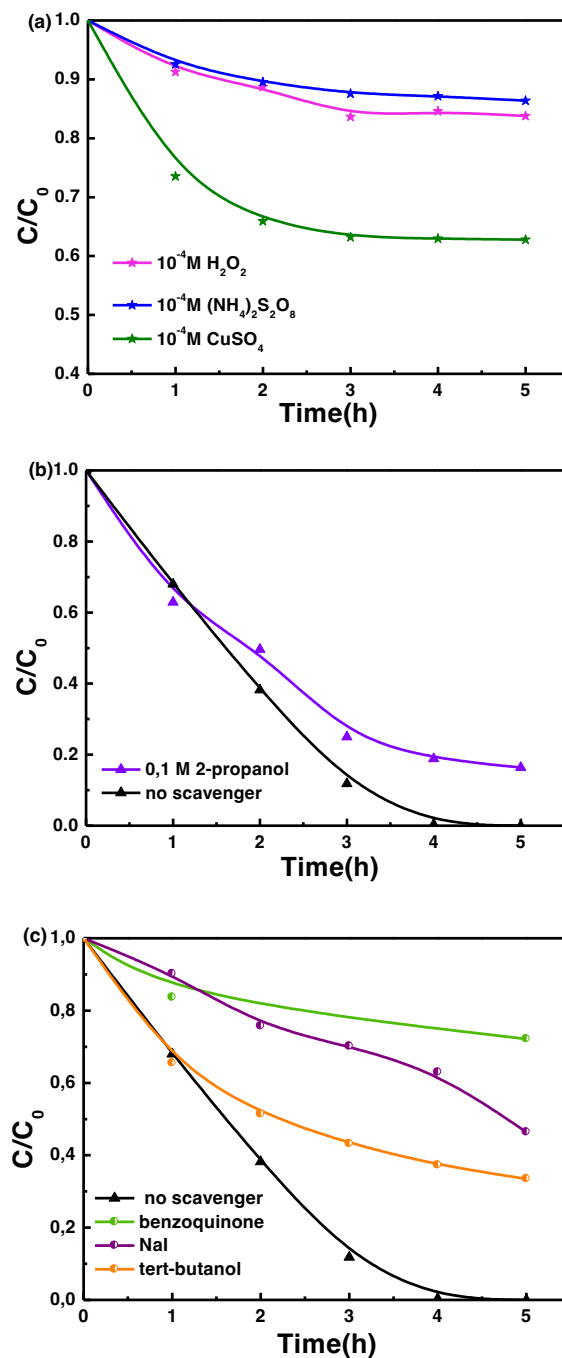

Fig. 7: Photocatalytic degradation of phenol using PPy-NS-c in the presence of **(a)** different electron scavengers, **(b)** both electron and hole scavengers, and **(c)** superoxide and hydroxyl radical scavengers

2-propanol (0.1 M) was used as hole and HO^\bullet scavenger. **Fig. 7b** shows that addition of 2-

propanol does not affect the photodegradation rate (which is 85% after 5 h). Furthermore, to confirm the role of HO[•] and O₂^{•-} radicals, tert-butanol and NaI were used as free HO[•] and surface HO[•] radical scavengers [79], and benzoquinone was used as the O₂^{•-} radical scavengers [23]. As shown in **Fig. 7c**, the rate of phenol degradation significantly decreases with benzoquinone (O₂^{•-} scavenger) addition indicating the crucial role of O₂^{•-} radical. In addition, it was found that the rate of photocatalytic degradation increased with NaI (surface HO[•] radical scavenger) and tert-butanol (free HO[•] radical scavenger). The result also shows the surface HO[•] radicals are responsible for the degradation of phenol compared with free HO[•] radicals owing to the small detected quantity of HO[•] using Tris (hydroxymethyl) aminomethane as a probe (**Table S2**)[64]. All these experiments demonstrate that photocatalytic degradation of phenol by PPy NS is mainly caused by O₂^{•-} superoxide radical formed from the reduction of dioxygen (O₂).

To further understand the photocatalytic activity of PPy nanostructures, their electronic properties were investigated. **Fig. 8a** shows the cyclic voltammetry (CV) curve of PPy-NS- γ , PPy-NS-c and PPy-bulk, which was used to evaluate the energy levels of the lowest unoccupied molecular orbital (LUMO) and the highest occupied molecular orbital (HOMO) from the ionization potential and the electronic affinity and to calculate the band gap of PPy (**Fig. S10, Table S3**). Specifically, the main oxidation (p-doping) process occurs at onset potentials of 0.07 V (PPy-NS-c) and 1.41 V (PPy-NS- γ), while reduction (n-doping) process starts at -1.72 V (PPy-NS-c) and -0.38 V (PPy-NS- γ). The energy levels of the LUMO/HOMO, for PPy-NS- γ and PPy-NS-c were respectively determined: -4.18 eV/-5.97 eV and -2.84 eV/-5.16 eV. The band gap was estimated to be 1.79 eV and 2.32 eV, respectively, which are remarkably smaller than the band gap of TiO₂ (3.20 eV). Actually, lower band gap implies the

possibility of activation of the polymer nanostructures under visible light with potential application in optoelectronics, photocatalysis or electrocatalysis. Recently, in our group, CP nanostructures of PDPB, P3HT and PEDOT with small band gaps and high photocatalytic activity under visible light were developed [23, 51, 52].

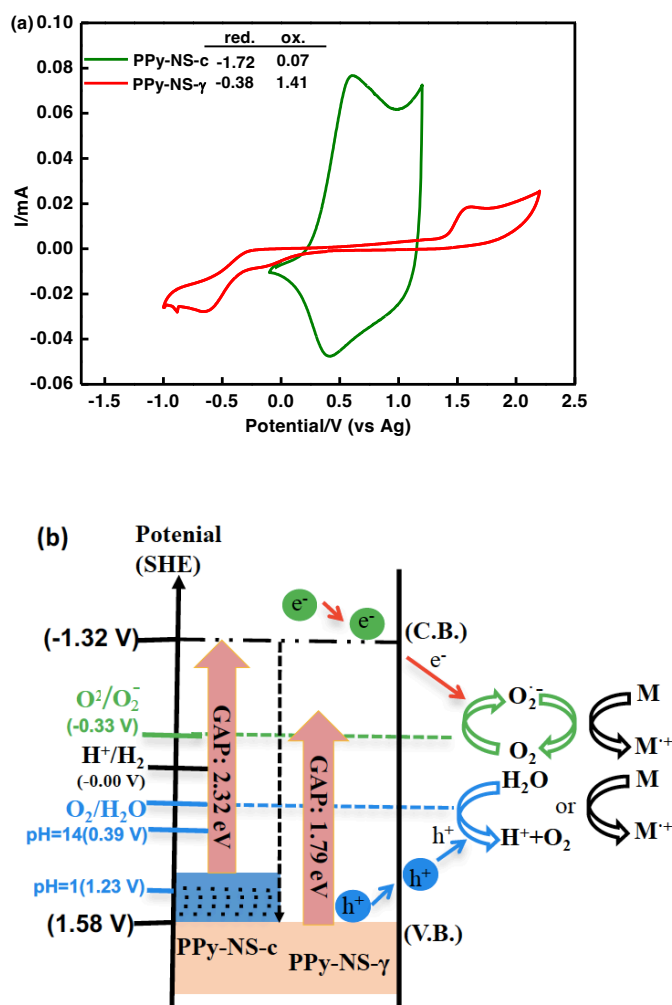

Fig. 8. (a) Cyclic Voltammetry of PPy recorded at 20 mV/s in acetonitrile and 0.1 M Tetrabutylammonium Perchlorate. Ferrocenium/ ferrocene (Fc/Fc⁺) redox potential has been measured at the end of each experiment in order to calibrate the pseudo reference electrode (0.241 V vs. Ag in the present study). The energetic levels of PPy are obtained by the following equation: $E_{\text{HOMO}} (\text{eV}) = - (4.8 + E_{\text{ox_onset}} - 0.241)$ and $E_{\text{LUMO}} (\text{eV}) = - (4.8 + E_{\text{red_onset}} - 0.241)$. (b) Possible photocatalytic mechanism with charge separation in PPy nanostructures with electron reducing oxygen and the hole oxidizing water.

Based on the above results, a possible photocatalytic mechanism of PPy nanostructures was proposed as illustrated in **Fig. 8b**. The generated charge carriers under both UV or visible light irradiation and the reactive oxygen species (ROS) are responsible for the oxidation and the degradation of the organic model pollutant (phenol or MO). Our results indicate that $O_2^{\bullet-}$ is the main radical responsible of degradation of the organic pollutant and their mineralization.

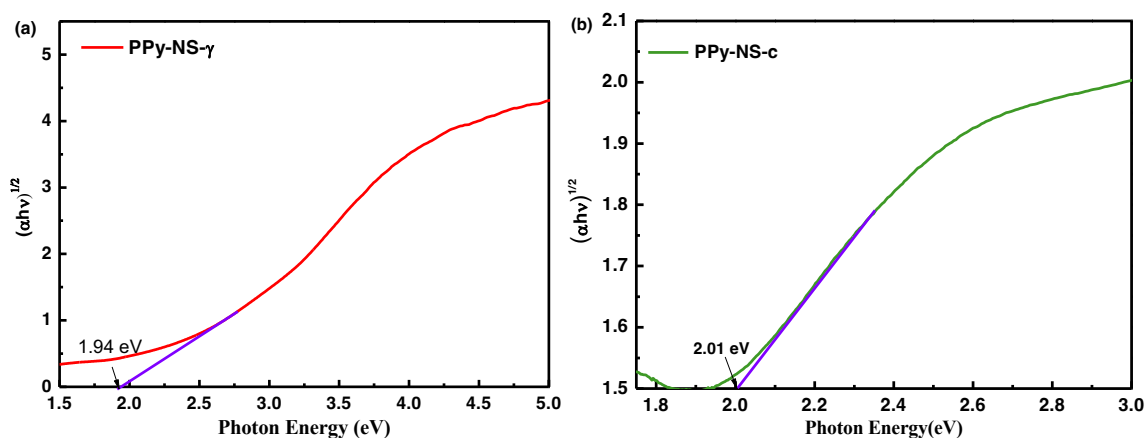

Fig. 9. Kubelka-Munk plots and band gap energy estimation of PPy-NS- γ (a) and PPy-NS-c (b) for direct transition.

The optical band gap energy (E_g) of PPy was estimated by Kubelka-Munk method. The corresponding E_g can be determined by the linear portion of $(\alpha h\nu)^n$ vs. $(h\nu)$ plot, where α , h , ν and k are the absorption coefficient, Planck constant, and light frequency, respectively. The value of n is equal to 2 for the indirect band gap and 1/2 for the direct band gap. **Figure 9** presents the Kubelka-Munk plots for PPy samples used to estimate the E_g associated with the direct transitions. As a result, the E_g of PPy-NS- γ and PPy-NS-c is about 1.94 eV and 2.01 eV. The results are quite similar to the band gap of PPy-NSs from CV calculation (**Figure 8 and Table S2**). The variation of the band gap

values obtained by calculation by Kubelka-Munk and CV methods can be explained by numerous reasons, which include geometrical arrangement and electronic configuration of the constituting elements, charge imbalance, oxygen vacancies and defects on the polymer surface.

4. Conclusions

PPy nanostructures were obtained by two different methods of polymerization: PPy-NS-c were successfully synthesized by chemical oxidation with Fe^{3+} in hexagonal mesophases (used as soft templates) and PPy-NS- γ were obtained by radiolytic polymerization. PPy-NS-c and PPy-NS- γ nanostructures show much higher photocatalytic activities under ultraviolet and visible light irradiation compared with PPy-bulk (synthesized without any template). The photocatalytic activity of the PPy nanostructures is close to that of plasmonic silver nanoparticles modified TiO_2 under visible light. Our experiments demonstrate that $\text{O}_2^{\cdot-}$ radicals are the main radical responsible for the degradation of phenol and MO. Nanostructuring of the CP is a key factor for their application in photocatalysis. These photocatalysts are stable with cycling. These results open interesting perspectives of using conjugated polymer nanostructures for different applications in photocatalysis: water and air treatment, self-cleaning surfaces and water splitting. Further studies will focus on design of composite materials based PPy heterojunctions for efficient solar hydrogen conversion and solar fuel production.

Acknowledgements

X.Y. gratefully acknowledges the financial support from China Scholarship Council (CSC). The authors thank Patricia Beaunier (LRS, UPMC, Sorbonne Université) for TEM observations. This work was supported by the IDEX Paris-Saclay and IRS MOMENTOM.

References

- [1] G. Wang, L. Xu, J. Zhang, T. Yin, D. Han, Enhanced photocatalytic activity of powders (P25) via calcination treatment, *International Journal of Photoenergy*, 2012 (2012) 1-9.
- [2] M. Méndez-Medrano, E. Kowalska, A. Lehoux, A. Herissan, B. Ohtani, S. Rau, C. Colbeau-Justin, J. Rodríguez-López, H. Remita, Surface Modification of TiO₂ with Au Nanoclusters for Efficient Water Treatment and Hydrogen Generation under Visible Light, *The Journal of Physical Chemistry C*, 120 (2016) 25010-25022.
- [3] D. Yang, Y. Sun, Z. Tong, Y. Tian, Y. Li, Z. Jiang, Synthesis of Ag/TiO₂ nanotube heterojunction with improved visible-light photocatalytic performance inspired by bioadhesion, *The Journal of Physical Chemistry C*, 119 (2015) 5827-5835.
- [4] L. Wu, F. Li, Y. Xu, J.W. Zhang, D. Zhang, G. Li, H. Li, Plasmon-induced photoelectrocatalytic activity of Au nanoparticles enhanced TiO₂ nanotube arrays electrodes for environmental remediation, *Applied Catalysis B: Environmental*, 164 (2015) 217-224.
- [5] B. Sambandam, A. Surenjan, L. Philip, T. Pradeep, Rapid synthesis of C-TiO₂: tuning the shape from spherical to rice grain morphology for visible light photocatalytic application, *ACS Sustainable Chemistry & Engineering*, 3 (2015) 1321-1329.
- [6] G. Mishra, K. Parida, S. Singh, Facile fabrication of S-TiO₂/β-SiC nanocomposite photocatalyst for hydrogen evolution under visible light irradiation, *ACS Sustainable Chemistry & Engineering*, 3 (2015) 245-253.
- [7] G.N. Nomikos, P. Panagiotopoulou, D.I. Kondarides, X.E. Verykios, Kinetic and mechanistic study of the photocatalytic reforming of methanol over Pt/TiO₂ catalyst, *Applied Catalysis B: Environmental*, 146 (2014) 249-257.
- [8] X.-j. Wang, W.-y. Yang, F.-t. Li, Y.-b. Xue, R.-h. Liu, Y.-j. Hao, In situ microwave-assisted synthesis of porous N-TiO₂/g-C₃N₄ heterojunctions with enhanced visible-light photocatalytic properties, *Industrial & Engineering Chemistry Research*, 52 (2013) 17140-17150.
- [9] M.N. Chong, B. Jin, C.W. Chow, C. Saint, Recent developments in photocatalytic water treatment technology: a review, *Water research*, 44 (2010) 2997-3027.
- [10] A. Rostami-Vartooni, M. Nasrollahzadeh, M. Salavati-Niasari, M. Atarod, Photocatalytic degradation of azo dyes by titanium dioxide supported silver nanoparticles prepared by a green method using *Carpobrotus acinaciformis* extract, *Journal of Alloys and Compounds*, 689 (2016) 15-20.

- [11] H. Cheng, B. Huang, Y. Dai, Engineering BiOX (X= Cl, Br, I) nanostructures for highly efficient photocatalytic applications, *Nanoscale*, 6 (2014) 2009-2026.
- [12] C. Zhou, C. Lai, P. Xu, G. Zeng, D. Huang, C. Zhang, M. Cheng, L. Hu, J. Wan, Y. Liu, In situ grown AgI/Bi₁₂O₁₇Cl₂ heterojunction photocatalysts for visible light degradation of sulfamethazine: efficiency, pathway, and mechanism, *ACS Sustainable Chemistry & Engineering*, 6 (2018) 4174-4184.
- [13] S. Zinatloo-Ajabshir, M.S. Morassaei, M. Salavati-Niasari, Nd₂Sn₂O₇ nanostructures as highly efficient visible light photocatalyst: Green synthesis using pomegranate juice and characterization, *Journal of Cleaner Production*, 198 (2018) 11-18.
- [14] S. Zinatloo-Ajabshir, M.S. Morassaei, M. Salavati-Niasari, Facile fabrication of Dy₂Sn₂O₇-SnO₂ nanocomposites as an effective photocatalyst for degradation and removal of organic contaminants, *Journal of colloid and interface science*, 497 (2017) 298-308.
- [15] M.S. Morassaei, S. Zinatloo-Ajabshir, M. Salavati-Niasari, Nd₂Sn₂O₇ nanostructures: New facile Pechini preparation, characterization, and investigation of their photocatalytic degradation of methyl orange dye, *Advanced Powder Technology*, 28 (2017) 697-705.
- [16] M.S. Morassaei, S. Zinatloo-Ajabshir, M. Salavati-Niasari, New facile synthesis, structural and photocatalytic studies of NdOCl-Nd₂Sn₂O₇-SnO₂ nanocomposites, *Journal of Molecular Liquids*, 220 (2016) 902-909.
- [17] A. Abbasi, M. Hamadani, M. Salavati-Niasari, S. Mortazavi-Derazkola, Facile size-controlled preparation of highly photocatalytically active ZnCr₂O₄ and ZnCr₂O₄/Ag nanostructures for removal of organic contaminants, *Journal of colloid and interface science*, 500 (2017) 276-284.
- [18] M. Hassanpour, H. Safardoust-Hojaghan, M. Salavati-Niasari, Degradation of methylene blue and Rhodamine B as water pollutants via green synthesized Co₃O₄/ZnO nanocomposite, *Journal of Molecular Liquids*, 229 (2017) 293-299.
- [19] G. Liao, S. Chen, X. Quan, H. Yu, H. Zhao, Graphene oxide modified g-C₃N₄ hybrid with enhanced photocatalytic capability under visible light irradiation, *Journal of Materials Chemistry*, 22 (2012) 2721-2726.
- [20] H. Safardoust-Hojaghan, M. Salavati-Niasari, Degradation of methylene blue as a pollutant with N-doped graphene quantum dot/titanium dioxide nanocomposite, *Journal of cleaner production*, 148 (2017) 31-36.
- [21] M. Mahdiani, A. Sobhani, M. Salavati-Niasari, Enhancement of magnetic, electrochemical and photocatalytic properties of lead hexaferrites with coating graphene and CNT: sol-gel auto-combustion synthesis by valine, *Separation and Purification Technology*, 185 (2017) 140-148.

- [22] S. Ghosh, N.A. Kouamé, L. Ramos, S. Remita, A. Dazzi, A. Deniset-Besseau, P. Beaunier, F. Goubard, P.-H. Aubert, H. Remita, Conducting polymer nanostructures for photocatalysis under visible light, *Nature materials*, 14 (2015) 505-511.
- [23] D. Floresyona, F. Goubard, P.-H. Aubert, I. Lampre, J. Mathurin, A. Dazzi, S. Ghosh, P. Beaunier, F. Brisset, S. Remita, L. Ramos, H. Remita, Highly active poly (3-hexylthiophene) nanostructures for photocatalysis under solar light, *Applied Catalysis B: Environmental*, 209 (2017) 23-32.
- [24] D.B. Kayan, F. Köleli, Simultaneous electrocatalytic reduction of dinitrogen and carbon dioxide on conducting polymer electrodes, *Applied Catalysis B: Environmental*, 181 (2016) 88-93.
- [25] K. Wang, H. Wu, Y. Meng, Z. Wei, Conducting polymer nanowire arrays for high performance supercapacitors, *Small*, 10 (2014) 14-31.
- [26] Z. Yin, Q. Zheng, Controlled Synthesis and Energy Applications of One-Dimensional Conducting Polymer Nanostructures: An Overview, *Advanced Energy Materials*, 2 (2012) 179-218.
- [27] S.-Y. Huang, P. Ganesan, B.N. Popov, Development of conducting polypyrrole as corrosion-resistant catalyst support for polymer electrolyte membrane fuel cell (PEMFC) application, *Applied Catalysis B: Environmental*, 93 (2009) 75-81.
- [28] C. Chiang, Y.-W. Park, A. Heeger, H. Shirakawa, E. Louis, A.G. MacDiarmid, Conducting polymers: Halogen doped polyacetylene, *The Journal of Chemical Physics*, 69 (1978) 5098-5104.
- [29] C.K. Chiang, C. Fincher Jr, Y.W. Park, A.J. Heeger, H. Shirakawa, E.J. Louis, S.C. Gau, A.G. MacDiarmid, Electrical conductivity in doped polyacetylene, *Physical Review Letters*, 39 (1977) 1098.
- [30] S. Ghosh, A.-L. Teillout, D. Floresyona, P. de Oliveira, A. Hagège, H. Remita, Conducting polymer-supported palladium nanoplates for applications in direct alcohol oxidation, *International Journal of Hydrogen Energy*, 40 (2015) 4951-4959.
- [31] S. Ghosh, S. Bera, S. Bysakh, R.N. Basu, Highly Active Multimetallic Palladium Nanoalloys Embedded in Conducting Polymer as Anode Catalyst for Electrooxidation of Ethanol, *ACS applied materials & interfaces*, 9 (2017) 33775-33790.
- [32] S. Ghosh, T. Maiyalagan, R.N. Basu, Nanostructured conducting polymers for energy applications: towards a sustainable platform, *Nanoscale*, 8 (2016) 6921-6947.
- [33] S. Sardar, P. Kar, H. Remita, B. Liu, P. Lemmens, S.K. Pal, S. Ghosh, Enhanced charge separation and FRET at heterojunctions between semiconductor nanoparticles and conducting polymer nanofibers for efficient solar light harvesting, *Scientific reports*, 5 (2015) 17313.
- [34] S. Ghosh, R. N. Basu, H. Remita “Conducting Polymers Nanostructures as Novel Materials for Efficient Solar Light Harvesting” in "Visible-Light-Active Photocatalysis: Nanostructured Catalyst

Design, Mechanisms, and Applications" by S. Ghosh (Editor) by Wiley-VCH Verlag GmbH & Co. KGaA, April, 2018, Chapter 9, Wiley, (2018) 227-252.

[35] X. Wang, K. Maeda, A. Thomas, K. Takanebe, G. Xin, J.M. Carlsson, K. Domen, M. Antonietti, A metal-free polymeric photocatalyst for hydrogen production from water under visible light, *Nature materials*, 8 (2009) 76.

[36] Y. Wang, H. Li, J. Yao, X. Wang, M. Antonietti, Synthesis of boron doped polymeric carbon nitride solids and their use as metal-free catalysts for aliphatic C–H bond oxidation, *Chemical Science*, 2 (2011) 446-450.

[37] C. Zhou, C. Lai, D. Huang, G. Zeng, C. Zhang, M. Cheng, L. Hu, J. Wan, W. Xiong, M. Wen, Highly porous carbon nitride by supramolecular preassembly of monomers for photocatalytic removal of sulfamethazine under visible light driven, *Applied Catalysis B: Environmental*, 220 (2018) 202-210.

[38] C. Zhou, C. Lai, P. Xu, G. Zeng, D. Huang, Z. Li, C. Zhang, M. Cheng, L. Hu, J. Wan, Rational Design of Carbon-Doped Carbon Nitride/Bi₁₂O₁₇C₁₂ Composites: A Promising Candidate Photocatalyst for Boosting Visible-Light-Driven Photocatalytic Degradation of Tetracycline, *ACS Sustainable Chemistry & Engineering*, 6 (2018) 6941-6949.

[39] C. Zhou, C. Lai, C. Zhang, G. Zeng, D. Huang, M. Cheng, L. Hu, W. Xiong, M. Chen, J. Wang, Semiconductor/boron nitride composites: synthesis, properties, and photocatalysis applications, *Applied Catalysis B: Environmental*, 238 (2018) 6-18.

[40] Z. Cui, C. Coletta, A. Dazzi, P. Lefrancois, M. Gervais, S. Néron, S. Remita, Radiolytic method as a novel approach for the synthesis of nanostructured conducting polypyrrole, *Langmuir*, 30 (2014) 14086-14094.

[41] T. Bahry, Z. Cui, A. Deniset, M. Gervais, B. Thanh-Tuân, S. REMITA, An alternative radiolytic route for synthesizing conducting polymers in an organic solvent, *New Journal of Chemistry*, 42 (2018) 8704-8716.

[42] Y. Lattach, A. Deniset-Besseau, J.-M. Guigner, S. Remita, Radiation chemistry as an alternative way for the synthesis of PEDOT conducting polymers under “soft” conditions, *Radiation Physics and Chemistry*, 82 (2013) 44-53.

[43] Y. Lattach, C. Coletta, S. Ghosh, S. Remita, Radiation-Induced Synthesis of Nanostructured Conjugated Polymers in Aqueous Solution: Fundamental Effect of Oxidizing Species, *ChemPhysChem*, 15 (2014) 208-218.

- [44] C. Coletta, Z. Cui, P. Archirel, P. Pernot, J.-L. Marignier, S. Remita, Electron-induced growth mechanism of conducting polymers: A coupled experimental and computational investigation, *The Journal of Physical Chemistry B*, 119 (2015) 5282-5298.
- [45] Z. Cui, C. Coletta, R. Rebois, S. Baiz, M. Gervais, F. Goubard, P.-H. Aubert, A. Dazzi, S. Remita, Radiation-induced reduction–polymerization route for the synthesis of PEDOT conducting polymers, *Radiation Physics and Chemistry*, 119 (2016) 157-166.
- [46] C. Coletta, Z. Cui, A. Dazzi, J.-M. Guigner, S. Néron, J.-L. Marignier, S. Remita, A pulsed electron beam synthesis of PEDOT conducting polymers by using sulfate radicals as oxidizing species, *Radiation Physics and Chemistry*, 126 (2016) 21-31.
- [47] Z. Cui, C. Coletta, T. Bahry, J.-L. Marignier, J.-M. Guigner, M. Gervais, S. Baiz, F. Goubard, S. Remita, A novel radiation chemistry-based methodology for the synthesis of PEDOT/Ag nanocomposites, *Materials Chemistry Frontiers*, 1 (2017) 879-892.
- [48] S. Ghosh, L. Ramos, S. Remita, A. Dazzi, A. Deniset-Besseau, P. Beaunier, F. Goubard, P.-H. Aubert, H. Remita, Conducting polymer nanofibers with controlled diameters synthesized in hexagonal mesophases, *New Journal of Chemistry*, 39 (2015) 8311-8320.
- [49] S. Ghosh, N.A. Kouame, S. Remita, L. Ramos, F. Goubard, P.-H. Aubert, A. Dazzi, A. Deniset-Besseau, H. Remita, Visible-light active conducting polymer nanostructures with superior photocatalytic activity, *Scientific reports*, 5 (2015) 18002.
- [50] S. Ghosh, L. Ramos, H. Remita, Swollen hexagonal liquid crystals as smart nanoreactors: implementation in materials chemistry for energy applications, *Nanoscale*, 10 (2018) 5793-5819.
- [51] S. Ghosh, H. Remita, L. Ramos, A. Dazzi, A. Deniset-Besseau, P. Beaunier, F. Goubard, P.-H. Aubert, F. Brisset, S. Remita, PEDOT nanostructures synthesized in hexagonal mesophases, *New Journal of Chemistry*, 38 (2014) 1106-1115.
- [52] S. Ghosh, N.A.Kouamé, L.Ramos, S. Remita, A. Dazzi, A. Deniset-Besseau, P. Beaunier, F. Goubard, P.-H. Aubert & H. Remita, Conducting polymer nanostructures for photocatalysis under visible light, *Nature Materials*, 14 (2015) 505-511.
- [53] S. Naficy, N. Stoboi, P.G. Whitten, G.M. Spinks, G.G. Wallace, Evaluation of encapsulating coatings on the performance of polypyrrole actuators, *Smart materials and structures*, 22 (2013) 075005.
- [54] Y. Shi, L. Pan, B. Liu, Y. Wang, Y. Cui, Z. Bao, G. Yu, Nanostructured conductive polypyrrole hydrogels as high-performance, flexible supercapacitor electrodes, *Journal of Materials Chemistry A*, 2 (2014) 6086-6091.

- [55] Y. Huang, J. Tao, W. Meng, M. Zhu, Y. Huang, Y. Fu, Y. Gao, C. Zhi, Super-high rate stretchable polypyrrole-based supercapacitors with excellent cycling stability, *Nano Energy*, 11 (2015) 518-525.
- [56] Z. Zha, X. Yue, Q. Ren, Z. Dai, Uniform polypyrrole nanoparticles with high photothermal conversion efficiency for photothermal ablation of cancer cells, *Advanced materials*, 25 (2013) 777-782.
- [57] S. Jeon, J.M. Moon, E.S. Lee, Y.H. Kim, Y. Cho, An Electroactive Biotin-Doped Polypyrrole Substrate That Immobilizes and Releases EpCAM-Positive Cancer Cells, *Angewandte Chemie*, 126 (2014) 4685-4690.
- [58] T. Yao, T. Cui, H. Wang, L. Xu, F. Cui, J. Wu, A simple way to prepare Au@ polypyrrole/Fe₃O₄ hollow capsules with high stability and their application in catalytic reduction of methylene blue dye, *Nanoscale*, 6 (2014) 7666-7674.
- [59] S. De Vito, C.R. Martin, Toward colloidal dispersions of template-synthesized polypyrrole nanotubules, *Chemistry of materials*, 10 (1998) 1738-1741.
- [60] Y. Yang, M. Wan, Microtubules of polypyrrole synthesized by an electrochemical template-free method, *Journal of Materials Chemistry*, 11 (2001) 2022-2027.
- [61] D. Wang, Y. Wang, X. Li, Q. Luo, J. An, J. Yue, Sunlight photocatalytic activity of polypyrrole-TiO₂ nanocomposites prepared by 'in situ' method, *Catalysis Communications*, 9 (2008) 1162-1166.
- [62] S. Gu, B. Li, C. Zhao, Y. Xu, X. Qian, G. Chen, Preparation and characterization of visible light-driven AgCl/PPy photocatalyst, *Journal of Alloys and Compounds*, 509 (2011) 5677-5682.
- [63] Q. Wang, L. Zheng, Y. Chen, J. Fan, H. Huang, B. Su, Synthesis and characterization of novel PPy/Bi₂O₂CO₃ composite with improved photocatalytic activity for degradation of Rhodamine-B, *Journal of Alloys and Compounds*, 637 (2015) 127-132.
- [64] V. Diesen, M. Jonsson, Tris (hydroxymethyl) aminomethane as a Probe in Heterogeneous TiO₂ Photocatalysis, *Journal of Advanced Oxidation Technologies*, 15 (2012) 392-398.
- [65] L. Qiong, P. Sritharathikhun, S. Motomizu, Development of novel reagent for Hantzsch reaction for the determination of formaldehyde by spectrophotometry and fluorometry, *Analytical sciences*, 23 (2007) 413-417.
- [66] E. Pena dos Santos, M.S. Tokumoto, G. Surendran, H. Remita, C. Bourgaux, P. Dieudonné, E. Prouzet, L. Ramos, Existence and stability of new nanoreactors: highly swollen hexagonal liquid crystals, *Langmuir*, 21 (2005) 4362-4369.

- [67] G. Surendran, M.S. Tokumoto, E. Pena dos Santos, H. Remita, L. Ramos, P.J. Kooyman, C.V. Santilli, C. Bourgaux, P. Dieudonné, E. Prouzet, Highly swollen liquid crystals as new reactors for the synthesis of nanomaterials, *Chemistry of materials*, 17 (2005) 1505-1514.
- [68] M. Wang, Emerging Multifunctional NIR Photothermal Therapy Systems Based on Polypyrrole Nanoparticles, *Polymers*, 8 (2016) 373.
- [69] Y. Wang, Z. Lu, Z. Zhu, X. Zhao, N. Gao, D. Wang, Z. Hua, Y. Yan, P. Huo, M. Song, Enhanced selective photocatalytic properties of a novel magnetic retrievable imprinted ZnFe₂O₄/PPy composite with specific recognition ability, *RSC Advances*, 6 (2016) 51877-51887.
- [70] C. MA, P. SG, S. Shashwati, Synthesis and characterization of polypyrrole (PPy) thin films, *Soft Nanoscience Letters*, 1 (2011) 6-10.
- [71] M. Karim, C. Lee, M. Lee, Synthesis of conducting polypyrrole by radiolysis polymerization method, *Polymers for Advanced Technologies*, 18 (2007) 916-920.
- [72] S. Ghosh, N. Bhandary, S. Basu, R.N. Basu, Synergistic Effects of Polypyrrole Nanofibers and Pd Nanoparticles for Improved Electrocatalytic Performance of Pd/PPy Nanocomposites for Ethanol Oxidation, *Electrocatalysis*, 8 (2017) 329-339.
- [73] J. Nayak, S.K. Mahadeva, J. Kim, Characteristics of flexible electrode made on cellulose by soluble polypyrrole coating, *Proceedings of the Institution of Mechanical Engineers, Part C: Journal of Mechanical Engineering Science*, 226 (2012) 2605-2609.
- [74] M.A. Chougule, S.G. Pawar, P.R. Godse, R.N. Mulik, S. Sen, V.B. Patil, Synthesis and characterization of polypyrrole (PPy) thin films, *Soft Nanoscience Letters*, 1 (2011) 6.
- [75] X. Chen, N. Yu, L. Zhang, Z. Liu, Z. Wang, Z. Chen, Synthesis of polypyrrole nanoparticles for constructing full-polymer UV/NIR-shielding film, *RSC Advances*, 5 (2015) 96888-96895.
- [76] K.-J. Ahn, Y. Lee, H. Choi, M.-S. Kim, K. Im, S. Noh, H. Yoon, Surfactant-templated synthesis of polypyrrole nanocages as redox mediators for efficient energy storage, *Scientific reports*, 5 (2015) 14097.
- [77] N. Paradee, A. Sirivat, Synthesis of poly (3, 4-ethylenedioxythiophene) nanoparticles via chemical oxidation polymerization, *Polymer International*, 63 (2014) 106-113.
- [78] A.L. Luna, D. Dragoie, K. Wang, P. Beaunier, E. Kowalska, B. Ohtani, D. Bahena Uribe, M.A. Valenzuela, H. Remita, C. Colbeau-Justin, Photocatalytic Hydrogen Evolution Using Ni-Pd/TiO₂: Correlation of Light Absorption, Charge-Carrier Dynamics, and Quantum Efficiency, *The Journal of Physical Chemistry C*, 121 (2017) 14302-14311.

- [79] B. Abramović, V. Despotović, D. Šojić, N. Finčur, Mechanism of clomazone photocatalytic degradation: hydroxyl radical, electron and hole scavengers, *Reaction Kinetics, Mechanisms and Catalysis*, 115 (2015) 67-79.
- [80] Y. Tao, Z. Cheng, K. Ting, X. Yin, Photocatalytic degradation of phenol using a nanocatalyst: the mechanism and kinetics, *Journal of Catalysts*, 2013 (2012) 1-6.
- [81] T. Chen, Y. Zheng, J.-M. Lin, G. Chen, Study on the photocatalytic degradation of methyl orange in water using Ag/ZnO as catalyst by liquid chromatography electrospray ionization ion-trap mass spectrometry, *Journal of the American Society for Mass Spectrometry*, 19 (2008) 997-1003.
- [82] M.S. Morassaei, S. Zinatloo-Ajabshir, M. Salavati-Niasari, Simple salt-assisted combustion synthesis of $\text{Nd}_2\text{Sn}_2\text{O}_7\text{-SnO}_2$ nanocomposites with different amino acids as fuel: an efficient photocatalyst for the degradation of methyl orange dye, *Journal of Materials Science: Materials in Electronics*, 27 (2016) 11698-11706.